

Technical data sheet

ELECTRIC
ICE RESURFACER

engo

ice arena equipment

ENG



NEW

Ice Panther

DESIGNED FOR
HIGH-LEVEL MULTI-PURPOSE
ICE STADIUMS



Ice fields up to
2.500 m²



Blade width
2.000 to 2.300 mm



Snow tank volume
3,0 m³ (compr. 3,8 m³)



Water tank volume
1.000 to 1.500 L

Technical data sheet

ELECTRIC ICE RESURFACER

engo
ice arena equipment



NEW



IcePanther

NEXT-LEVEL INNOVATION

Proven technology, enhanced for the future!

The IcePanther continues to set new standards in ice resurfacing. With its cutting-edge technology, it combines efficiency, sustainability and user-friendly operation. Its modern design ensures high performance and precision, while features like integrated LED advertising, advanced battery technology and optimized operator comfort make it a top choice for professional ice maintenance. Backed by years of expertise, the IcePanther leads the way in innovation and reliability.

DESIGNED FOR
**HIGH-LEVEL MULTI-PURPOSE
ICE STADIUMS**



KEY FACTS

	ICE FIELDS	up to 2.500 m ²
	DIMENSIONS L X W X H *	4.260 x 2.150 x 2.200 mm
	BLADE WIDTH	2.000 to 2.300 mm
	WATER TANK VOLUME	1.000 to 1.500 L
	SNOW TANK VOLUME	3,0 m ³ (compressed 3,8 m ³)
	BATTERY	battery depending on choice

POWER FOR FULLY ELECTRIC OPERATION

- Low maintenance battery
- Maintenance-free battery
- Lithium batteries
- Each with matching charger

* Length x width x height







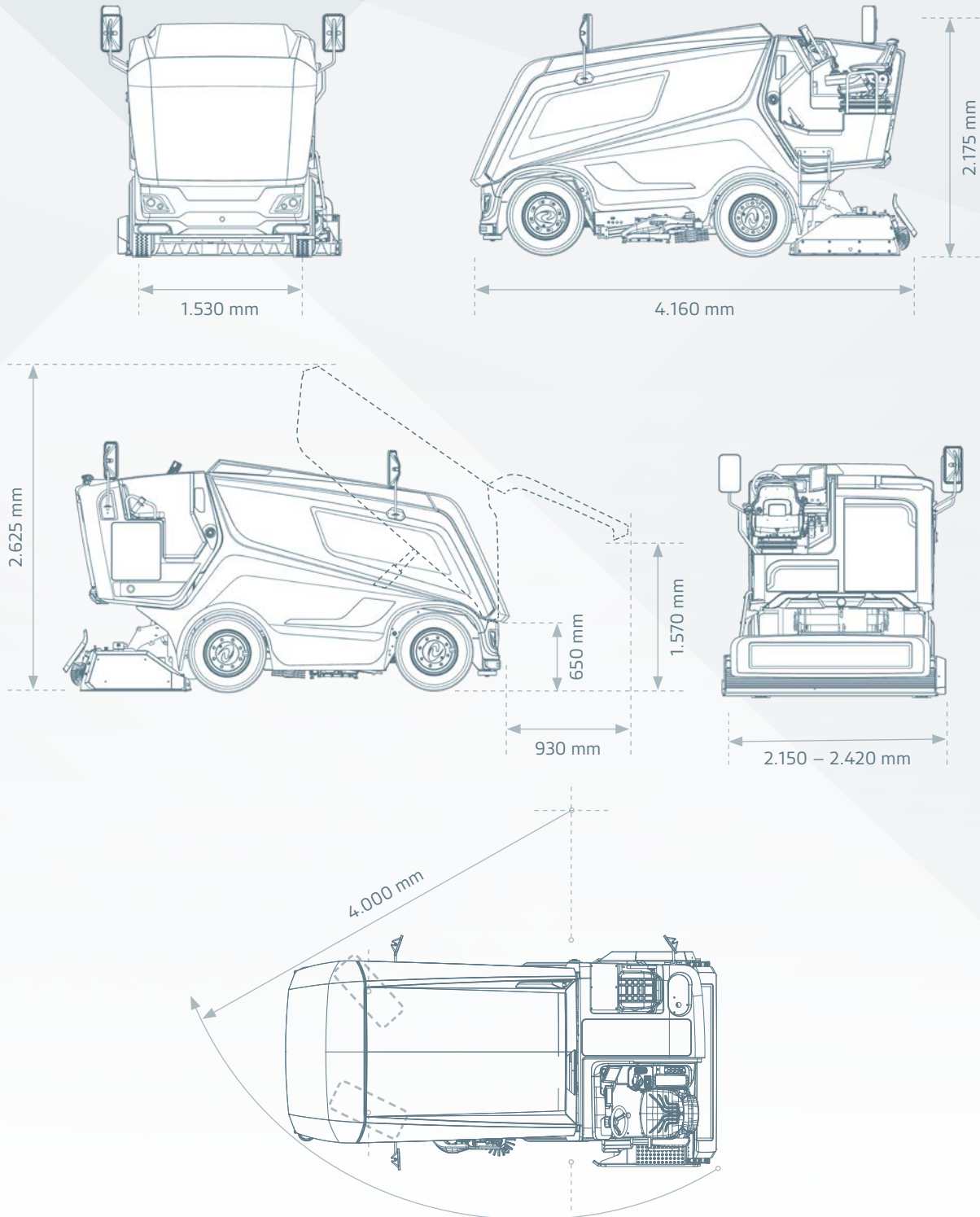









KEY FACTS

Technical specifications



RANGE OF ELECTRIC ICE RESURFACERS

ICE EDGER	<p>IceDingo</p> <ul style="list-style-type: none"> • Application: Ice field boarders • Blade width: 360 mm • Dimensions: 1.400 x 470 x 1.200 mm * 	 
SMALL ICE RINKS (INDOOR AND OUTDOOR)	<p>IceFox</p> <ul style="list-style-type: none"> • Application: Ice fields up to 800 m² • Blade width: 1.400 mm • Dimensions: 3.000 x 1.500 x 1.700 mm * 	 
	<p>IcePuma</p> <ul style="list-style-type: none"> • Application: Ice fields up to 1.200 m² • Blade width: 1.700 mm • Dimensions: 3.500 x 1.830 x 1.900 mm * 	 
	<p>IceWolf SMART / CLASSIC / PRO</p> <ul style="list-style-type: none"> • Application: Ice fields up to 1.800 m² • Blade width: 2.000 to 2.300 mm • Dimensionen: 4.060 x 2.150 x 2.200 mm * 	 
HIGH-LEVEL MULTI-PURPOSE ICE STADIUMS	<p>IcePanther</p> <ul style="list-style-type: none"> • Application: Ice fields up to 2.500 m² • Blade width: 2.000 to 2.300 mm • Dimensions: 4.260 x 2.150 x 2.200 mm * 	 
	<p>IceTiger</p> <ul style="list-style-type: none"> • Application: Ice fields up to 3.000 m² • Blade width: 2.300 to 2.500 mm • Dimensions: 4.000 x 2.420 x 2.300 mm * 	 
	<p>IceLion</p> <ul style="list-style-type: none"> • Application: Ice fields up to 7.000 m² • Blade width: 2.500 mm • Dimensions: 4.600 x 2.660 x 2.350 mm * 	 

* Length x width x height





ice arena equipment

Website: www.engo-ice.cn

Hotline: 4009001881



**ICE RESURFACERS
DASHER BOARDS
ACCESSORIES**

*Powerful technology for
smooth ice surfaces since 1979*

*Specifications are subject to change.
For current product information
please contact the Engo Company.*

© Copyright by Engo

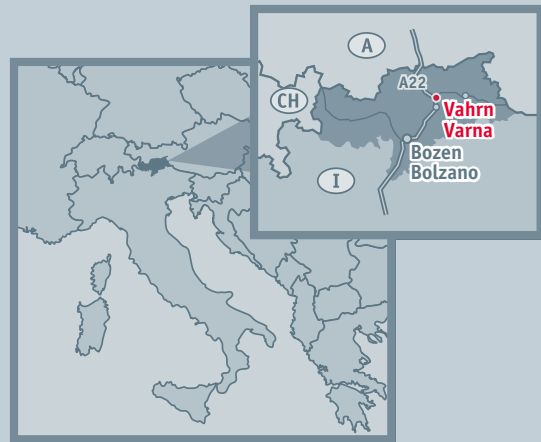

CERTIFICATION



MEMBER

LEGAL NOTICE
Editor: Engo GmbH / S.r.l., Via Forch 9, 39040 Varna (BZ) Italia
Pictures: Archive Engo, Photographer: City-Press GmbH Picture agency, mm design, Christof Schiner, FOTO KLICK, Hannes Niederkeller,
Vanna Antonello, Exide Technologies, RDYPOW Industrial Park, Adobe Stock – www.stock.adobe.com; Sportpoint; Gorodokoff Productions OU, sidorevstok,
Von 103trn, Slójik / MjJ., www.shutterstock, iStock – www.iStockphoto.com; ii-graphics, Jusun, BongklamThanjakij, daboost, Design by almedes.bz